

# NAXN BRONZE



- ▶ 80 PLUS® Bronze certified
- ▶ 100% Japanese electrolytic capacitors
- ▶ 12cm temperature controlled silent fan

NAXN BRONZE power supply series is 80 PLUS® Bronze certified with up to 88% efficiency, coming with 100% durable Japanese electrolytic capacitors, Active PFC circuit, multiple protection. Besides, it helps meet the EU ErP Lot 6 requirements. NAXN BRONZE provides durability, reliability, energy-saving designs, and is suitable for mainstream PC systems, media center, gaming builds.



### Features

- ▶ 80 PLUS® Bronze certified  
Meet 80 PLUS® Bronze standard with 83-88% efficiency @ 20-100% load

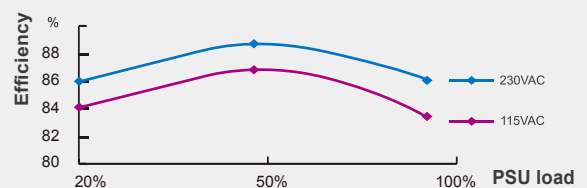

- ▶ 100% Japanese electrolytic capacitors  
Highest component standards for maximum durability and stability



ENERMAX PSU + ErP Lot 6 Compliant system

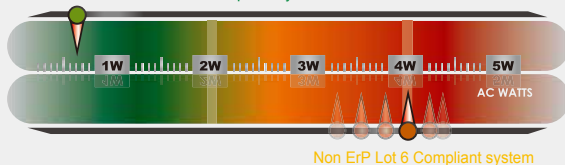

- ▶ ErP Lot 6 ready!  
Help system meet ErP Lot 6 (<1W at standby mode) with high efficiency +5Vsb circuitry (with ErP Lot 6 enabled motherboard)

**Fully continuous output @ 40°C**  
 NAXN BRONZE high-end components and advance layout ensure non-stop operation

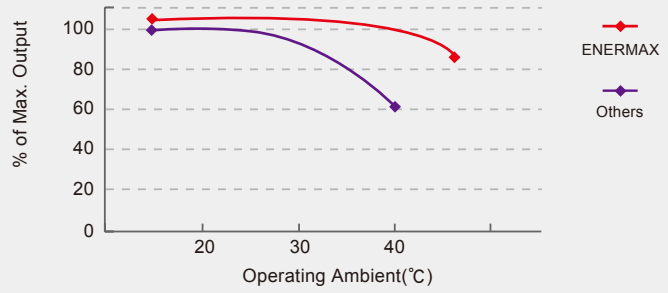

**World ready**  
 115-230VAC auto-adjustment input for universal use. Active PFC with PF value up to 0.99, reducing the reactive power loss to the minimum

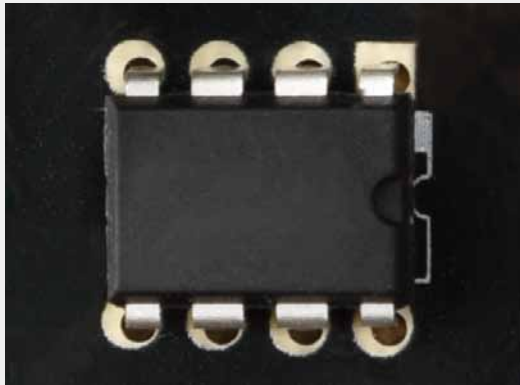





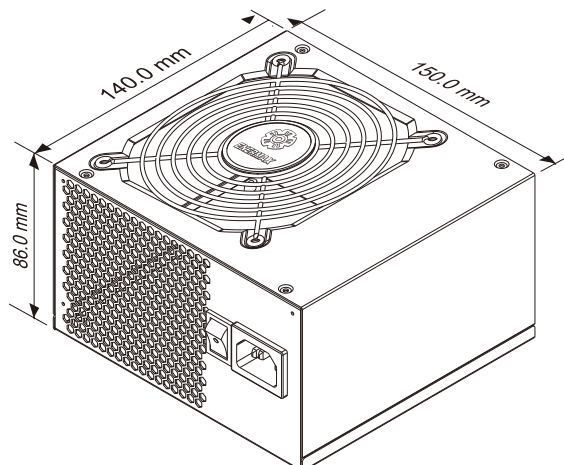

**SafeGuard**  
 Multiple protection circuitry of OVP, UVP, OPP, SCP and SIP protects your system

## Dimensions







unit:mm



## Cables & Connectors

cable						
	24P Mainboard	4+4P (8P) CPU	6+2P (8P) PCI-E	SATA	4P Molex	FDD
ETP350AWT	1	1	2	4	3	1
ETP450AWT	1	1	2	5	4	1
ETP500AWT	1	1	2	5	4	1

## Specifications

Model Number	ETP350AWT		ETP450AWT		ETP500AWT	
AC Input Voltage	115V~230VAC, 47-63Hz, Active PFC					
AC Input Current	5A		7A		7A	
DC Output						
	Rated	Combined	Rated	Combined	Rated	Combined
+3.3V	16A	90W	17A	100W	18A	110W
+5V	15A		16A		17A	
+12V	26A	312W	34A	408W	38A	456W
-12V	0.3A	3.6W	0.3A	3.6W	0.3A	3.6W
+5Vsb	2.5A	12.5W	2.5A	12.5W	2.5A	12.5W
Total power	350W		450W		500W	
Dimensions	150(W) x 86(H) x 140(D) mm					
     						
Shipping Information						
Bar code	EAN : 4713157722386		EAN : 4713157722393		EAN : 4713157722409	
Box dimension	200(W) x 230(D) x 98(H) mm					
Gross Weight / unit	1.3kg		1.5kg		1.5kg	
Carton dimension	418(W) x 428(D) x 255(H) mm					
Q'ty / carton	8					
Gross Weight / carton	10.4kg		12kg		12kg	